



A Clear Path to Electrical Power Excellence!

CW500
Power Quality Analyzer



Electrical power measurement is a key for innovation.

The Yokogawa CW500 is a portable power meter that utilizes a current clamp sensor for use in the field enabling consumption and power quality measurement of the power line.

By the navigation screen of the unit, the connection setting and detail setting of the unit is simple and direct by following the screens.

Keys which directly turn on desired measuring screens allow comfortance at the use of field.

Stored measured data are easily accessed by a click on the file with included PC software.

Simplified power measuring – Several direct keys keep you simple and direct access to Voltage/Current/Power/Power factor/Phase Angle/Frequency/Integrated power/Demand by values or by a trend graph.

Firmly capture line power quality issue – Captures short period power malfunction conforming IEC 6100-4-30 Class S.

User support – Function of Quick Start Guide to support secure wiring and setting of units.

Features

- Power Measure and Logging
- Power Quality Measuring
- User Support
- Analysis of Data and Report Generation

Power Measuring and Logging

- Simultaneously measures 3 CH Voltage input, 4 CH current clamp-on probe input, 2 CH DCV input.
- Displays value list or trend graph screen of Instantaneous/Average/Maximum/Minimum of Voltage/Current/Power/Power factor/Phase Angle/Phase Advanced Capacitance Calculation and DCV input.
- Integration Value of Active/Reactive/Apparent Energy is each displayed by consumption and generation.
- Demand value can be monitored by screens of present power consumption compared to aimed demand power value.



User Support

Quick Start Guide Function:

- Start Guide Function supports secure wiring and setting before measuring.
- Automatically recognize the type of current clamp-on probe.

Vector Display:

- Indicates Voltage and Current phase difference and values between input channels of voltage and current.
- Checks whether the wiring is appropriate or not.

Power Quality Measuring

Measure Temporary Malfunction of Power Line

- Captures temporary malfunction phenomena of power line which causes malfunction or destruction of devices by types (Voltage swell, Voltage dip, Voltage interruption, Transient overvoltage, inrush current) as an event by high sampling rate of 24 μ s and RMS calculation.
- Event data contains the type of malfunction, occurred time or occurrence finish time, measured value and waveform of voltage and current of all channels for approx. 200 ms period.
- Measurement method conforms to IEC standard 61000-4-30 Class S

Measure Continuous Malfunction of Power Line

Harmonics

- Measure and display graphs and list of up to the 50th Harmonic components of voltage, current and power for each phase and in total.

Waveform

- Displays with up to 10 or 12 waveforms of voltage and current for each CH.

Flicker

- Measures, 1 minute flicker (Pst, 1 min), short flicker (Pst) and long flicker (Plt).

Unbalance rate

- Displays voltage and current unbalance rate on 3 phase wiring.

Analysis of Data and Report Generation

CW500Viewer (Included PC software)

- Automatically generates graph and report by simple clicking on a file data displayed on screen.
- Uniform management of main unit settings
- Realtime measuring by USB communication.

Types of data

- Power data, Power quality event data, Main Unit Setting data, Screen capture data.

Memory card and interface

- SD Memory card, USB communication, Bluetooth communication (Available for USA, Canada and Japan only)

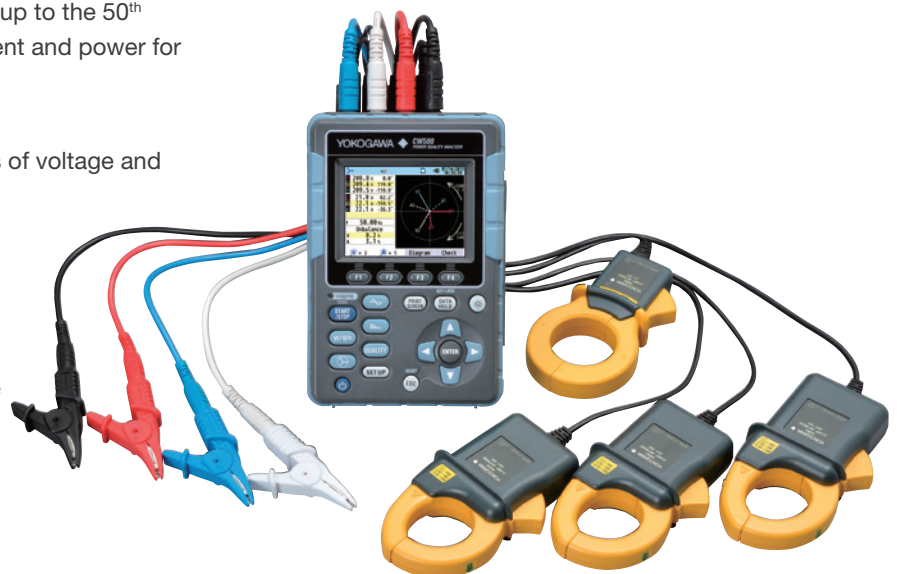

Function

Power Measuring

Power line and Input Channel: 3 CH Voltage, 4 CH for Current Clamp Probe.

1P2W (up to 4 system), 1P3W (up to 2 system), 3P3W2current (up to 2 system), 3P3W3current, 3P4W

Power measuring item:

Instantaneous, Average, Maximum and Minimum values:

Voltage/Current/Power (Active, Reactive, Apparent)/Power factor/ Phase Angle/Frequency/Calculated Phase Shift Condensior/DC voltage value 2 CH.

Integration Value

- Energy (Active, Reactive, Apparent) each by consumption and generation
- Demand (Occurrence of max. demand time, current demand, estimated demand value)

Recording Interval Period:

1/2/5/10/15/20/30 second, 1/2/5/10/15/20/30 minute, 1 hour/2 hours

Recording method

Manual, time setting, period setting

Estimated Recording Length with 2 GB SD card.

Interval	Power recording	+Harmonics
1 sec.	13 days	3 days
1 min.	Over 1 year	3 months
30 min.	Over 10 years	Over 7 years

- The recording length shortens according to the number of power quality events.
- Only included SD memory card or dedicated SD memory card is guaranteed.

Various Measuring Screen

- List display, Zoom display by 4 or 8 division, Trend graph display
- Integration Value Display for Energy
- Demand List display of value, Demand Graph display for change of period, Demand Graph display for whole recording

List Display

Hems of measuring values can be selected with position.

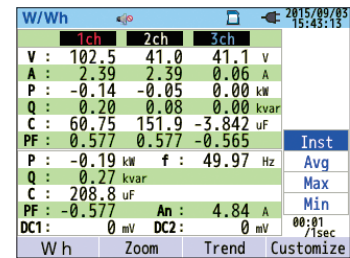

Zoom Display

Zoom display can be selected by 4 or 8 division.

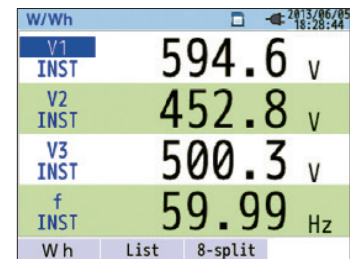

Trend Graph

Trend graph of voltage/current/power/power factor/frequency/advanced phase condensior/DC voltage

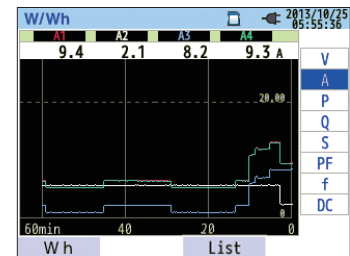

Energy Display

List of Active, Apparent, Reactive by consumption or generation

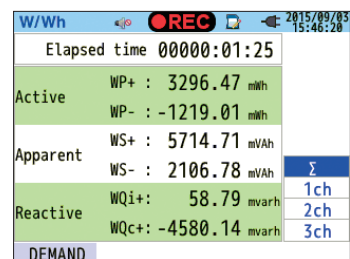

Demand measuring

Demand is the average power value of a specific period (usually 30 minutes). Contract with the power supplier conditionally concerns the maximum average power value between period for the consumption fee. This function supports how to maintain within the target consumption by monitoring the estimated demand value to the setting rate, with the maximum demand value.

List of Demand Value

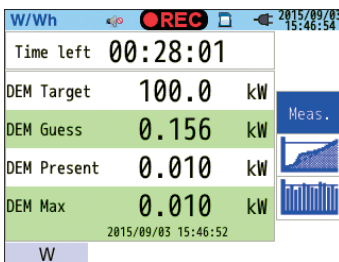

Graph display of change on specific period

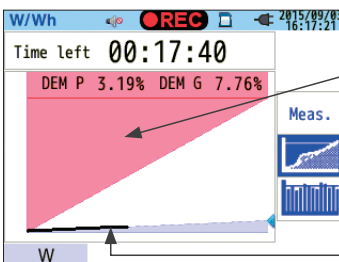

When the estimated demand value line is displayed inside this area, it mean that the demand value will be over the target value.

Estimated demand value

Graph display of whole demand trend

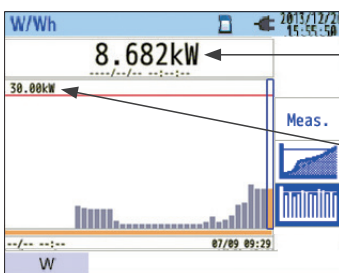

Max. demand value

Aimed target demand value

Analysis and Report of recorded data

Analysis and report is enabled by simply clicking on the desired data on software screen. Analysis is capable by trend graph, average, maximum and minimum value of voltage, current, power, power factor. Report generating could be set by day time, night time, working day, off day or monthly period. Additionally energy data to quantity of crude oil barrels, or to CO₂ can be converted.

Trend analysis graph

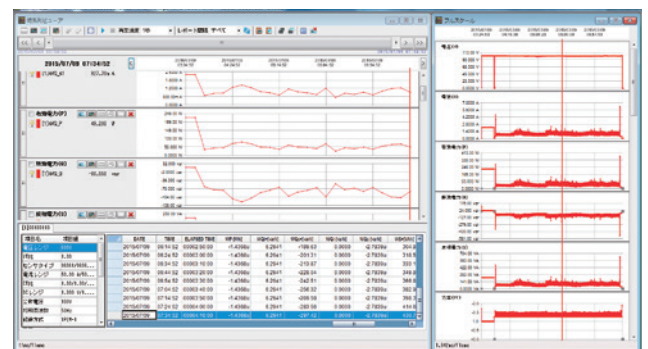

Sample of report

Test Report				2015/09/07	
Started: 2015/07/09 02:24:52					
End: 2015/07/09 07:42:38					
Analysis period: 02:00/14Hours/15Min.48Sec.					
Integrated amount	Total period	kWh	kVAh	kVAh	0.4
	Weekday/Average	0.0	0.0	0.0	0.0
	Weekend/Average	—	—	—	—
	Nighttime	100.0	100.0	100.0	100.0
Conversion	Cude oil equivalent (kg)		CO2emissions(CO2)		
	Weekday	Daytime	0.0	0.0	0.0
	Weekday	Night	0.0	0.0	0.0
	Weekend	Night	—	—	—
Total		0.0	0.0	0.0	0.0
Emission rate for oil: 0.000519000kWh					
Cost	Unit: ¥/kWh		Electric energy(kWh)		Cost: ¥/kWh
	Weekday	Daytime	0.0000	0.0	0.0000
	Weekday	Night	0.0000	0.2	0.0000
	Weekend	Daytime	0.0000	—	—
Total		0.0000	0.2	0.0000	—
Power	kW		kVAR	kVA	Power factor
	Max	0.3753	0.1119	0.6401	0.9990
	Min	0.0000	-0.8188	0.0000	-0.7900
	Average	0.0522	-0.0899	0.1029	-0.8899
Channel parameter	1ch				
	Max	100.4000			
	Min	0.0000			
	Average	100.8076			
Voltage[V]	Max	6.2540			
	Min	0.0000			
Current[A]	Average	0.9859			
	Max				
Active power(kW)	Min				
	Average				
Apparent power (kVA)	Min				
	Average				
Reactive power (kVAR)	Min				
	Average				
Power factor	Max				
	Average				

Power Quality Function





Short period power line malfunctions such as voltage swells/dips/interruptions/transient overvoltage or inrush currents, or long period such as harmonic distortion, flicker may damage or reset your devices.

The CW500 helps to identify each of those short period malfunctions, by recording occurrence time, occurrence finish time and waveforms. Additionally there is a digital output on occurrence.

Long period malfunctions can be analyzed by harmonics, flicker, waveform or checking on the unbalance rate calculation for 3 phase measurement.

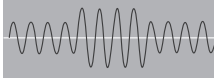
All data can be finalized to a report format with included software.

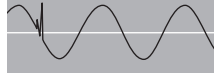
The CW500 conforms to the IEC standard of 61000-4-30 Class S.

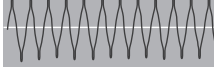
Power line malfunction phenomena	Example of cause and influence	Example of waveform	Notes
Voltage Swell	Lightnings or heavy load switching on power line may cause momentary swell on voltage.		
Voltage Dip	Generating moments on motor load may cause an inrush current and cause dips on voltage.		
Voltage interruption	Momentary or long interruption to power distribution by lightning or open breakers		Occurred time and waveform is recorded. Digital output is set on during the occurred period.
Transient overvoltage (impulse)	Lightning or heavy load switching on power line may cause momentary change on voltage.		
Inrush current	Generating moments on motor load may cause an inrush current.		
Flicker	Increase and decrease on certain phases could cause flickering distortion on voltage and currents.		Pst (1 min), Pst or Plt is measured.
Harmonics	Inverter and Thyristor circuits (phase control circuits) which are used for the control circuit of general devices could affect currents and cause harmonic distortion.		Up to 50 th harmonic contents are measured.
Unbalance rate	Heavy loading on a specific phase, could influence motor operation and could cause harmonic distortion.		Voltage and Current unbalance rate measured on vector screen for 3 phase

7 Power Quality Measuring Function

Capture temporary power line issues

Various kind of power issues are captured by high sampling rate of 24 μ s and overlapping RMS measuring by half cycles. They are recorded as an event by occurred time, occurrence finish time and waveforms are recorded.

- Main unit displays list of occurred issue by types.
- Recorded data are easily analyzed and report is generated by PC software.

Voltage swell
Voltage dip
Voltage Interrupt
Transient overvoltage
Inrush Current

Power line malfunction event

QUALITY	V	Time
216.0	V	2013/05/28 14:20:15
257.0	V	2013/05/28 14:20:15
206.0	V	2013/05/28 14:20:01
253.0	V	2013/05/28 14:20:01
22.00	V	2013/05/28 14:19:55
22.00	V	2013/05/28 14:19:55
540.0	A	2013/05/28 14:19:35
540.0	A	2013/05/28 14:19:35

Display event, timing and measurement

Waveforms and measured data are stored on a SD memory card.

Main operation

Test Report 2015/09/07

Item	Value	Unit	Limit
Voltage	239.5	V	230.0
Current	50.23	A	50.0
Power	12.0	W	10.0
Power Factor	0.804		0.8
Frequency	59.99	Hz	60.0

Analyze and report is created by PC

Capture continuous power line issues

Harmonic Measuring

- Displays components of up to the 50th Harmonics contents by individual channel or overall by graph or list
- Displays the maximum occurred point on graph.

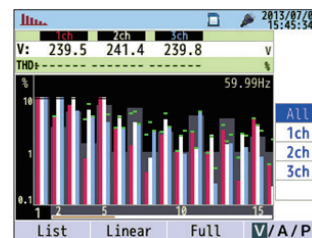

P	P1 1	P2 1	P1 2	P2 2
1	55.8	79.8	48.0	79.8
2	0.0	0.0	0.0	0.0
3	0.0	0.0	0.0	0.0
4	0.0	0.0	0.0	0.0
5	0.0	0.0	0.0	0.0
6	0.0	0.0	0.0	0.0
7	0.0	0.0	0.0	0.0
8	0.0	0.0	0.0	0.0
9	0.0	0.0	0.0	0.0
10	0.0	0.0	0.0	0.0

List display

Flicker

Displays list or graph of 1minute flicker (Pst, 1 min), short term flicker (Pst) or long term flicker (Plt).

QUALITY	V	2ch	3ch
V	230.0	230.4	230.5
Pst	0.804	1.028	1.017
Pst: 1min	0.804	1.026	1.022
MAX	0.804	1.035	1.034
Plt	0.804	1.027	1.025
MAX	0.804	1.028	1.028

f : 59.99 Hz

List display

Waveform

Displays voltage and current waveform by all or individually. It can be zoomed in and out by vertical or horizontal with rate selection below.

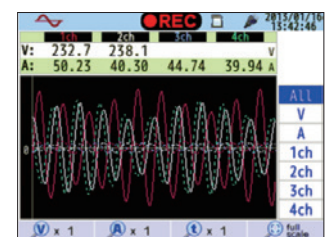

Vertical rate: 0.1, 0.5, 1, 2, 5, 10

Horizontal rate: 1, 2, 5, 10

User Support Function

User Friendly

Quick start guide and Automatic type of clamp identification

A quick start guide will show how to wire and how to set the range before measuring which ensures the settings are correct.

The sensor identification will detect the type of clamp-on probe and set the highest range of the type.

Start of guidance

PUSH "START/STOP"key and select "Quick start guide".

Recording item selection will be displayed.



Wiring

Select the wiring and the appropriate connection diagram will be displayed.

Connect the voltage probe and clamp-on probe accordingly.

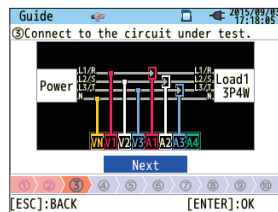

Wiring check/self diag./self id.

Wiring check, self check and type of clamp-on probe identification will be executed and the results will be displayed. If NG is displayed, detail could be confirmed by ENTER key.

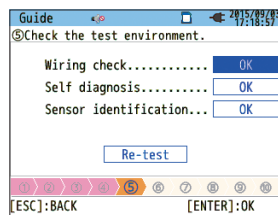

Recording setting

Set recording interval time and recording time or period.

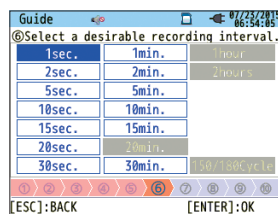

Power supply from measuring line

Power (under 240 VAC) can be supplied by using the "Power supply adapter" (sold separately).



Example diagram of power supply

Note: This is not available for EU region.

Leakage current measuring

External magnetic field effect is 0.002 A or less, at 400 A/m.

Yokogawa's proprietary technology has achieved a magnetic field impact amount of 30 ppm even in adjacent power lines (at 100 A), Below is an example to measure neutral line of 3 phase 4 line.

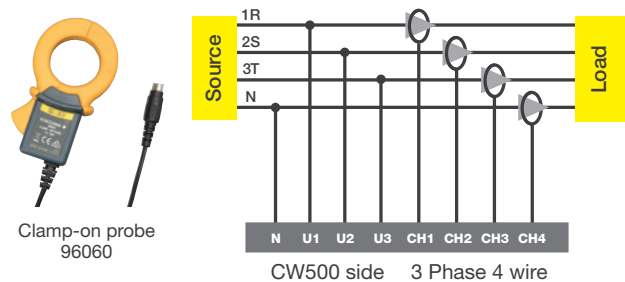

Multiple line measuring

4 system load measuring

Maximum of 4 systems is capable for 1 phase 2 line
Maximum of 2 systems is capable for 1 phase 3 line or 3 phase 3 line.

9 Software for Analysis and Setting (Free) CW500Viewer

Data analysis , making reports of data, making setting file and doing a real time measuring can be easily done with the CW500Viewer.

The data can be transferred by SD memory card, USB communication or Bluetooth communication (for USA, Canada, Japan only).

Graph and lists are created by a click on the data file.

- Graph and lists of the recorded data file are created by clicking on the desired data file. They can be displayed and copied on a clip board so it can be used on other software such as Word or Excel spread sheet.
- The time axis and measure axis can be zoomed in or out easily. With this capability, micro and macro changes, can be displayed desirably.
- Waveforms of power quality events (Voltage swell, voltage dips, voltage interrupt, transient overvoltage and inrush current) which are recorded by 200 ms period can be displayed and printed.
- The integrated data can be added on one graph which enables the whole energy integration data to be displayed.
- Integrated energy data can be scaled into CO₂ or crude oil value.

Settings management

- Setting data can be read out from and to the main unit via SD memory card, USB communication cable or Bluetooth communication*.
- Settings data can be easily edited saved and managed.

Real time measurement

- Real time measurement can be achieved up to 2 units simultaneously via USB communication or Bluetooth communication*

System requirement

OS	Windows 8/7/Vista (32 bit/64 bit)
CPU	Pentium 4 or Pentium Processor over 2 GHz
Display	1024 × 768 dots, 65536 colors or more
HDD (Hard-disk space required)	1 GByte or more (including Framework)
Others	.NET Framework (3.5)

Note: Windows is a registered trademark of Microsoft in the United States.
 Pentium is a registered trademark of Intel in the United States.
 Bluetooth is a registered trademark of Bluetooth SIG.
 Other company names or names of merchandise are trademarks of their company.

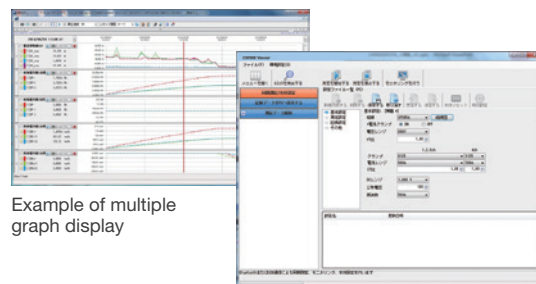

Example of multiple graph display

Example of setting display

*Only available for US, Canada and Japan.

Application

Power Measuring + Power Quality Examination

Examination of main power line quality for factory system control and assets

- Confirm to check quality of power line for factory system control and assets.
- Simultaneously measure the consumption of energy trend and consider solutions for energy saving.

CW500 not only continuously measures harmonics but captures malfunction of power line and records occurrence time with waveforms. Simultaneously it can measure power and leakage current of neutral phase. Additionally users can confirm the condition of assets when signals are connected to the DCV input channels.

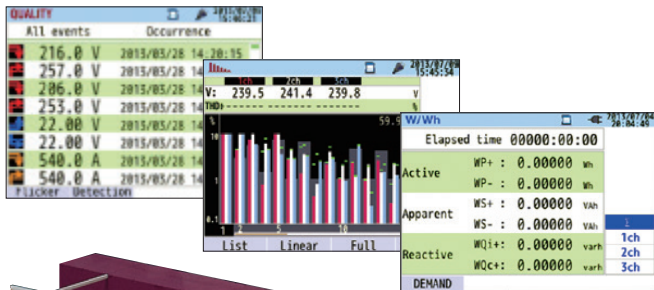

Leakage current

Voltage/Current/
Power/Power factor/
Demand/
Analog input 2 CH

Power Line Measuring Examination

LED lighting introduction for checking power saving effect

Introduce the effect of power saving to use LED lightning compared to the non LED lightning by measuring before and after.

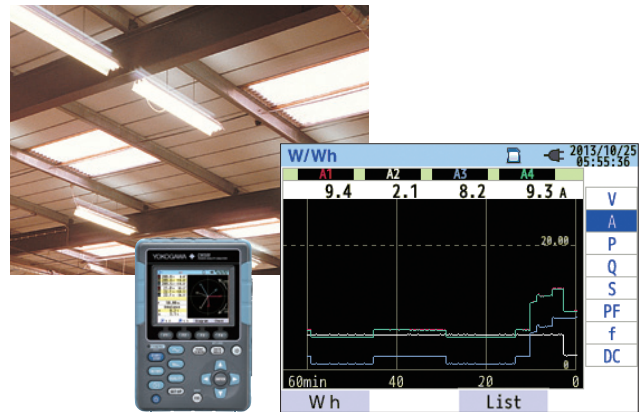

Checking power consumption of driving pumps of a manufacturing line

Inverters were applied to many driving pumps in a liquid manufacturing line.

Power consumption checking was needed to check the effect before and after.

Many settings to measure many pumps is easily and efficiently arranged by PC software. Additionally the power line quality is checked to be safely operated with the new inverters.

11 Improving power line of a printing factory by measuring harmonics (Printing factory)

Purpose: Investigation of the cause of periodic malfunction for printing machine.
Harmonics distortion on line could be the reason?

Measuring: CW500 merit

- Compact size and easy to carry.
- Up to 50th Harmonics measuring.
- Long term recording

Result: Confirming high level harmonic contents on 5th and 7th.

Found harmonics were generated by internal assets.
Especially 5th harmonics damages the direct reactor of condenser for improving power factor

Others

Improvement of Power factor for power efficiency

CW500 can calculate the appropriate condensor value by setting the aimed power factor value.
By setting the appropriate advanced condensor and improving the power factor, users will benefit for power saving with less load current and improve the capacity of the whole power system.

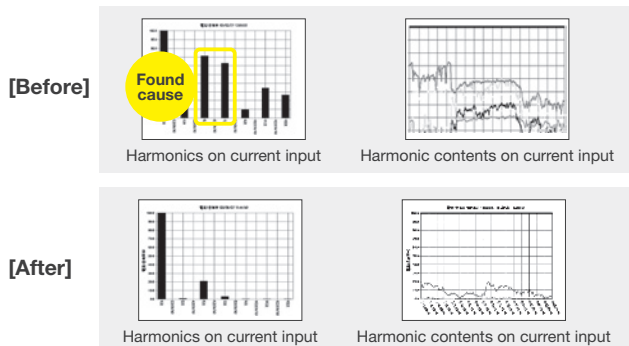

Effect of correspondence: Harmonic contents of 5th and after dropped and malfunction rate of printing machine decreased.

Confirmation of inflow harmonics

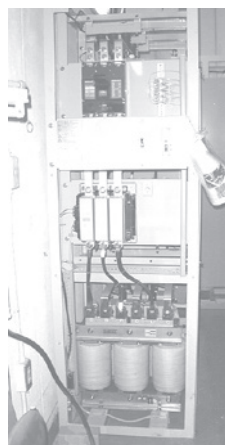
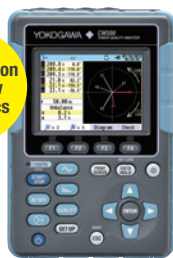

500kV transformers of factory "A".



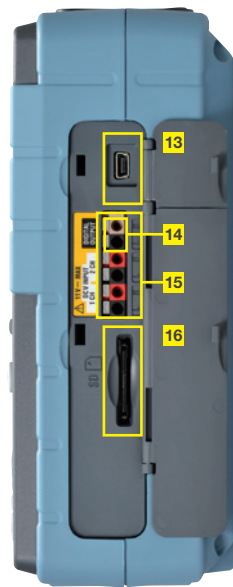
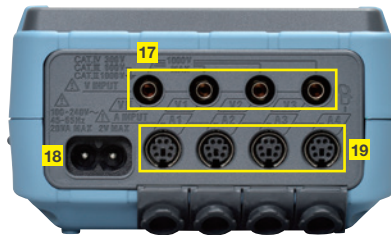



External Appearance



- | | | |
|---|---|---|
| <ul style="list-style-type: none"> 1 START/STOP SWITCH 2 Screen switch of W and Wh item 3 Vector and wiring check switch 4 Power button 5 Waveform screen switch 6 Harmonic screen switch 7 Power quality screen switch 8 Setting screen switch | <ul style="list-style-type: none"> 9 Print screen switch 10 Data Hold/Key lock (long press) 11 LCD Key/Contrast (long press)
Turn ON/OFF the display and change brightness and contrast by long press 12 Cursor and Enter Key 13 USB terminal
Mini B pin for PC communication | <ul style="list-style-type: none"> 14 Digital output terminal
Trigger signal output on event 15 Analog input terminal 2 CH
For 100 mV, 1 V, 10 V, DC input 16 SD card interface 17 Voltage input terminal 18 AC power supply input 19 Clamp-on probe connection |
|---|---|---|

Accessories

13 Clamp-on Probe (sold separately)

		For Leakage	For Load current				For load current (flexible type)		
Model code		96060	96061	96062	96063	96064	96065	96066	
Photo									
Measurable diameter		φ40 mm	φ18 mm	φ24 mm	φ30 mm	φ40 mm	φ110 mm	φ150 mm	
Input Range		AC 2 A	AC 50 A	AC 100 A	AC 200 A	AC 500 A	AC 1000 A	AC 300 A AC 1000 A AC 3000 A	
Output voltage		AC 50 mV (25 mV/A)	AC 500 mV	AC 500 mV	AC 500 mV	AC 500 mV	AC 500 mV	For each range AC 500 mV	
Accuracy	Level	50 Hz/ 60 Hz	±1.0% rdg ±0.05 mV	±0.5% rdg ±0.1 mV	±0.5% rdg ±0.1 mV	±0.5% rdg ±0.1 mV	±0.5% rdg ±0.1 mV	±0.8% rdg ±0.2 mV	
		40 Hz to 1 kHz	±2.0% rdg ±0.1 mV	±0.8% rdg ±0.2 mV	±1.0% rdg ±0.2 mV	±0.8% rdg ±0.2 mV	±1.0% rdg ±0.2 mV	±1.5% rdg ±0.4 mV	±1.0% rdg*
		1 kHz to 3.5 kHz	±3.0% rdg ±0.2 mV	±1.0% rdg ±0.4 mV	—	±1.0% rdg ±0.4 mV	—	—	
Accuracy Degree		—	Less than ±2.0° (0.5 to 50 A, 40 Hz to 3.5 kHz)	Less than ±2.0° (1 to 100 A, 45 Hz to 65 Hz)	Less than ±1.0° (2 to 200 A, 40Hz to 3.5kHz)	Less than ±1.0° (5 to 500 A, 45 Hz to 65 Hz)	Less than ±2.0° (45 Hz to 65 Hz) Less than ±3.0° (40 Hz to 1 kHz)	Less than ±1.0° (for each range/ 45 to 65 Hz)	
Max Circuit voltage		AC 300 Vrms	AC 300 Vrms	AC 300 Vrms	AC 600 Vrms	AC 600 Vrms	AC 600 Vrms	AC 600 Vrms	
Dimension		approx. 70(W) × 120(H) × 25(D) mm	approx. 52(W) × 106(H) × 25(D) mm (excluding pointed part)	approx. 60(W) × 100(H) × 26(D) mm	approx. 73(W) × 130(H) × 30(D) mm	approx. 81(W) × 128(H) × 36(D) mm	approx. 73(W) × 130(H) × 30(D) mm	approx. 61(W) × 111(H) × 43(D)mm	
Weight		approx. 230 g	approx. 170 g	approx. 160 g	approx. 240 g	approx. 260 g	approx. 170 g	approx. 950 g	

*45 to 65 Hz (measuring at the center of sensor)

Other accessory (sold separately)

Extension code
98082¹Power supply adapter
98031Portable case (for CW500)
93047Conversion Cable (Banana-DIN)
99073²
(Planned to be released)

*1 Extension code 98082 corresponds to below current probe. 96060, 96061, 96062

*2 The following clamp-on probe are able to be connected. 96030, 96033, 96036

Specifications

Model code		CW500-B0	CW500-B1
Bluetooth function		No Bluetooth Function	With Bluetooth Function ^{*1}
Wiring connections		1P2W (max. 4 systems), 1P3W (max. 2 systems), 3P3W (max. 2 systems), 3P3W3current, 3P4W	
Measurements items		Voltage, Current, Frequency, Active power, Reactive power, Apparent power, Active energy, Reactive energy, Apparent energy, Power factor, Phase Advancing Condenser, Neutral current, Demand, Harmonics, Power Quality (Swell/Dip/Interrupt/Transient overvoltage, Inrush current, Unbalance rate, IEC flicker	
Other function		Digital output, Analog DCV input function	
Voltage (RMS)	Range	600.0/1000 V	
	Accuracy	±0.2% rdg ±0.2% rng. (sine wave, 40 to 70 Hz)	
	Allowable input	1 to 120% (rms) of each range, 200% for peak of each range	
	Display range	0.15 to 130% of each range	
	Crest factor	3 or less	
	Sampling speed of voltage transient	24 µs	
Current (RMS)	Range	96060 (2 A type): 2000 mA 96061 (50 A type): 5000 mA/50 A/AUTO 96062 (100 A type): 10/100 A/AUTO 96063 (200 A type): 20/200 A/AUTO 96064 (500 A type): 50/500 A/AUTO 96065 (1000 A type): 100/1000 A/AUTO 96066 (3000 A type): 300/1000/3000 A	
	Accuracy	±0.2% rdg ±0.2% rng. + accuracy of clamp-on probe (sine wave, 40 to 70 Hz)	
	Allowable input	1 to 110% (rms) of each range, 200% for peak of each range	
	Display range	0.15 to 130% of each range	
	Crest factor	3 or less	
Active power	Accuracy	±0.3% rdg ±0.2% rng. + accuracy of clamp-on probe (Power factor 1, sine wave, 40 to 70 Hz)	
	Effect of Power Factor	±1.0% rdg (40 to 70 Hz, reading at power factor 0.5 against 1.0)	
Frequency meter range		40 to 70 Hz	
Power supply (AC Line)		AC100 to 240 V/50 to 60 Hz/7 VA max.	
Power supply (DC Battery)		Alkaline size AA battery LR6 or Ni-Mh (HR15-51) × 6 pcs Battery life approx. 3 hours (LR6 Backlight OFF)	
Internal memory		Flash memory (4 MB)	
External memory card		SD Card (2 GB)	
PC communication		USB Ver. 2.0	USB Ver. 2.0/Bluetooth Ver. 2.1 + EDR Class2 ^{*1}
Display		320 × 240 (RGB) Pixel, 3.5 inch color TFT	
Display update period		1 s	
Display Language		English, French, Spanish, Polish, Korean, Chinese, Japanese	
Temperature and humidity range		23±5°C, less than 85% RH (without condensation)	
Operating temperature and humidity range		0 to 45°C, less than 85% RH (without condensation)	
Storage temperature and humidity range		-20 to 60°C, less than 85% RH (without condensation)	
Dimensions		120 (W) × 175 (H) × 68 (D) mm	
Weight		Approx. 900 g (with battery)	
Included accessories (attached)		98078 Voltage Probe, 93046 Carrying case 97060 SD Memory Card 2 GB USB cable, Power cord, Quick manual, Alkaline size AA battery LR6 × 6pcs, Input terminal plate × 6 pcs, PC software (CD-ROM)	
Optional accessories (sold separately)		96060, 96061, 96062, 96063, 96064 (Clamp-on Probe) 96065, 96066 (Clamp-on probe, flexible type) 98031 (Power supply adapter) ^{*2} 93047 (Portable case with magnet)	

*1 Bluetooth model is available only for USA, Canada and Japan

*2 98031 Power supply adapter is not available for EU region.

15 Applicable Standard

Safety Standard	EN 61010-1 CAT IV 300 V, CAT III 600 V, CAT II 1000 V Pollution level 2 EN 61010-2-030 EN 61010-2-033 EN 61010-031
EMC*	EN 61326-1 Class A Table 2 EN 55011 Class A Group1
Power Quality	IEC 61000-4-30 Ed. 2 Class S, IEC 61000-4-15, IEC 61000-4-7
Wireless	FCC approval, IC approval, Radio Electric technology engineering Radio technology standard

*This is a Class A instrument designed for an industrial environment. Operation of this equipment in a residential area may cause radio interference, in which case users will be responsible for any interference which they cause.

Power list of choosing clamp-on probe

For 1P2W (multiply 2 for 1P3W and 3P3W, multiply 3 for 3P4W)

Voltage range	Clamp-on Probe Model code (rate) Current range											
	96061 (50 A)		96062 (100 A)		96063 (200 A)		96064 (500 A)		96065 (1000 A)		96066 (3000 A)	
	5000 mA	50.00 A	10.00 A	100.0 A	20.00 A	200.0 A	50.00 A	500.0 A	100.0 A	1000 A	300.0 A	3000 A
600.0 V	3000 W	30.00 kW	6000 W	60.00 kW	12.00 kW	120.0 kW	30.00 kW	300.0 kW	60.00 kW	600.0 kW	180.0 kW	1800 kW
1000 V	5000 W	50.00 kW	10.00 kW	100.0 kW	20.00 kW	200.0 kW	50.00 kW	500.0 kW	100.0 kW	1000 kW	300.0 kW	3000 kW

96060 is dedicated for leakage only and is incapable for power measuring

Model and suffix

Model code	Suffix code	Notes
CW500		Power Quality Analyzer
	-B0	No Bluetooth Function
	-B1	With Bluetooth Function*
	-D	AC code (UL/CSA)
	-F	AC code (VDE)
	-H	AC code (GB)
	-N	AC code (NBR)
	-P	AC code (KC)
	-R	AC code (SAA)
	-S	AC code (BS)

*Available for USA, Canada and Japan only

Accessories (included with CW500)

Model code	Model name	Notes
98078	Voltage Probe	1 set 4 pcs Red Black White Blue φ4 mm Approx. 3 m
93046	Carrying Case	CW500 and Clamp-on probe can be contained
97060	SD Memory Card (2 GB)	2 GB SD Memory Card

Relevant products

CW120 series Clamp on Power Meter

CW120/CW121 Simple and low cost model



Dim. 117 (W) × 161 (H) × 51 (D) mm
Approximately 0.6 kg

- 3P3W model 2 CH input (CW120), 3P4W model 3CH input (CW121)
- Frequency range: 45 Hz to 65 Hz, Basic power accuracy: ±(0.8% rdg + 0.4% rng)
- Multiple system (CW120: 3 system 1P2W, CW121: 4 system for 1P2W)
- Recording from 1 sec.
- Measuring voltage up to 400 V
- Communication protocol: Modbus, PC link

WT300E series Power Meter (Direct current input type)

WT332E/WT333E Compact three-phase model with optional harmonic measurement function



Dim. 213 (W) × 132 (H) × 350 (D) mm
Approximately 5 kg

- Three-phase model (three-phase, three-wire: two input elements; three-phase, four-wire: three input elements)
- Power measurement frequency range: DC and 0.1 Hz to 100 kHz
- Basic power accuracy: 0.1% of reading.
- Max. 3 channels simultaneous Harmonic measurement (needs /G5 option)
- A variety of other features, including line filter, maximum hold, and integration function with categorization of positive and negative polarity, and average active power function

WT310E/WT310EH Low-cost model providing mobility for standalone measurement of standby consumed power and rated power



Dim. 213 (W) × 88 (H) × 350 (D) mm
Approximately 3 kg

- Single-phase model
- Power measurement frequency range: DC and 0.1 Hz to 100 kHz (WT310EH: up to 20 kHz)
- Basic power accuracy: 0.1% of reading.
- Wide current input range (5 mA to 20 A) (WT310EH 1 A to 40 A)
- A variety of other features, including line filter, maximum hold, and integration function with categorization of positive and negative polarity, and average active power function

Accessories sold separately

Model code	Model name	Notes
96060	Clamp-on probe	φ40 mm AC 2 A, Leakage current measurement
96061	Clamp-on probe	φ18 mm AC 50 A, Load current measurement
96062	Clamp-on probe	φ24 mm AC 100 A, Load current measurement
96063	Clamp-on probe	φ30 mm AC 200 A, Load current measurement
96064	Clamp-on probe	φ40 mm AC 500 A, Load current measurement
96065	Clamp-on probe	max. approx. 110 mm AC 1000 A flexible type load current measurement
96066	Clamp-on probe	max. approx. 150 mm AC 3000 A, 3 CH Load current measurement
98082	Extension cable	Extension cable for Clamp-on Probe
98031*	Power supply adapter	Power supply from measure line (100 to 240 V)
93047	Portable case	Case with magnet
99073 (Planned to be released)	Conversion Cable (Banana-DIN)	for 96030, 96033, 96036

*Not available for EU region

Outline drawing

(Unit: mm)

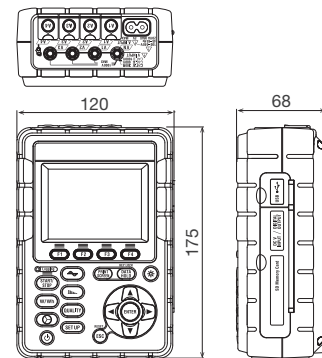

NOTICE

- Before operating the product, read the user's manual thoroughly for proper and safe operation.

YOKOGAWA

YOKOGAWA METERS & INSTRUMENTS CORPORATION

Global Sales Dept. /Phone: +81-422-52-6237 Facsimile: +81-422-52-6462
E-mail: tm@cs.jp.yokogawa.com

YOKOGAWA CORPORATION OF AMERICA
YOKOGAWA EUROPE B.V.
YOKOGAWA SHANGHAI TRADING CO., LTD.
YOKOGAWA ELECTRIC KOREA CO., LTD.
YOKOGAWA ENGINEERING ASIA PTE. LTD.
YOKOGAWA INDIA LTD.
YOKOGAWA ELECTRIC CIS LTD.
YOKOGAWA AMERICA DO SUL LTDA.
YOKOGAWA AUSTRALIA PTY. LTD.
YOKOGAWA MIDDLE EAST & AFRICA B.S.C(c)

Phone: +1-770-253-7000
Phone: +31-88-4641000
Phone: +86-21-6239-6363
Phone: +82-2-2628-3810
Phone: +65-6241-9933
Phone: +91-80-4158-6000
Phone: +7-495-737-7868
Phone: +55-11-5681-2400
Phone: +61-2-8870-1100
Phone: +973-17-358100

Facsimile: +1-770-254-0928
Facsimile: +31-88-4641111
Facsimile: +86-21-6880-4987
Facsimile: +82-2-2628-3899
Facsimile: +65-6241-2606
Facsimile: +91-80-2852-8656
Facsimile: +7-495-737-7869
Facsimile: +55-11-5681-4434
Facsimile: +61-2-8870-1111
Facsimile: +973-17-336100

YMI-KS-MI-SE01

Subject to Change without notice.
Copyright © 2015, Yokogawa Meters & Instruments Corporation
[Ed: 01/b]
Printed in Japan, 510(KP)

<http://tmi.yokogawa.com/>